

ZERTIFIKAT

Certificate

Franz Schneider Brakel GmbH + Co KG
Nieheimer Str. 38
D-33034 Brakel

wird für das Produkt/ for the product

Türdrücker und Türknäufe/
Door handles and Door knobs
DIN EN 1906:2012-12

4	7	--	0/D*	1	4	0	A
---	---	----	------	---	---	---	---

*Artikel/ Items 0 80 XXXX Klasse/ Class 0,
Artikel/ Items 0 81 XXXX Klasse/ Class D

mit der Produktbezeichnung/ with the product name

Rosettengarnitur/ Rosette set G1906

Art. Nr.:/ Item no. 0 80 1237 01310 6203
weitere Art. Nrn. siehe Ü-Matrix/ additional product versions, see matrix

gefertigt in der Fertigungsstätte/ manufactured in the production plant
Franz Schneider Brakel GmbH + Co KG
Nieheimer Str. 38 / Industriestr. 12
D-33034 Brakel

die Konformität mit dem Zertifizierungsprogramm Z0001 PIV CERT bestätigt
und das Recht zum Führen des PIV CERT Zeichens/
is in conformity with the certification program Z0001 PIV CERT and that the product is entitled to bear the symbol

in Verbindung mit der Registernummer **29V43** erteilt/
in conjunction with the registration number 29V43

PIV CERT Zertifizierungsvereinigung/
PIV CERT Association of certification
Wallstraße 41, D-42551 Velbert

Diesem Zertifikat liegt der Prüfbericht Nr. 29-1/14 des PIV zugrunde.
Erstausstellung 02/2014. Die Gültigkeit endet 02/2019./
This certificate is based on the test report no. 29-1/14 by PIV.
First issue 02/2014. End of the validity 02/2019.



O. Troska, Dipl.-Ing. (FH)
Leiter der Zertifizierungsstelle/
Director of the Certification Office
15. Mai/ May 2015

Produktbezeichnung: Rosettengarnitur/ Rosette set G 1906
Product definition:

Konstruktionsprinzip/ Construction principle

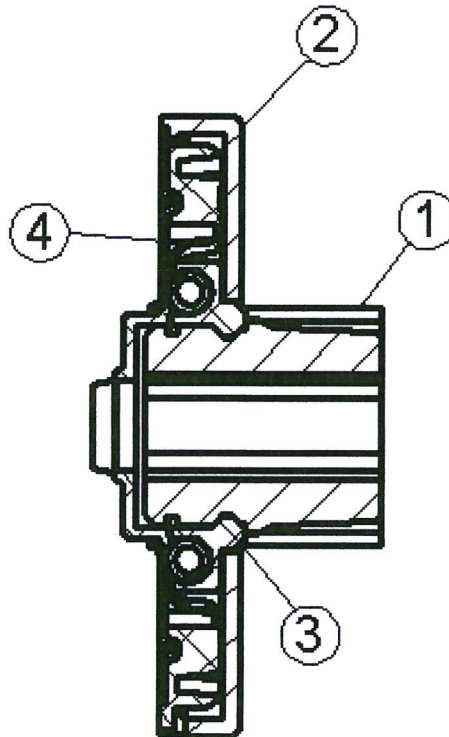

Türdrücker (Pos.1) ist nach Montage der Dekorkappe festdrehbar gelagert (Pos.2) in 7 mm breiter Kunststoffführung (Pos. 3) an Stahlunterteil (Pos. 4)./
Door handle (Pos. 1) is after the installation of the decorative cap, firmly pivoted (Pos. 2), in 7mm wide plastic guide (Pos. 3) to steel bottom part (Pos. 4).









Alle auf den folgenden Seiten dargestellten Kombinationen sind möglich./
All combinations shown on the following pages are available.

Oliver Troska, Dipl.-Ing. (FH)
Leiter der Zertifizierungsstelle/
Director of the Certification Office



Produktbezeichnung: Rosettengarnitur/ Rosette set G 1906

Product definition:

Rosetten/ Rosettes		Vierkant/ Square 8	Vierkant/ Square 9 FS
			
Modelle Türdrücker/ Versions of door handles			
10 1234		0 80 1234 013__ 6203	0 81 1234 013__ 6203
10 1235		0 80 1235 013__ 6203	0 81 1235 013__ 6203
10 1236		0 80 1236 013__ 6203	0 81 1236 013__ 6203
10 1237		0 80 1237 013__ 6203	0 81 1237 013__ 6203
10 1238		0 80 1238 013__ 6203	0 81 1238 013__ 6203
10 1239		0 80 1239 013__ 6203	0 81 1239 013__ 6203



Oliver Troska, Dipl.-Ing. (FH)
Leiter der Zertifizierungsstelle/
Director of the Certification Office